

Midi free-standing Beacons / LED Permanent-/ Blink-/ Revolving Light 829

LED Perm. Beacon RM 230VAC YE

Part No.: 829.337.68

**MECHANICAL DATA**

Height	200 mm
Diameter	98 mm
Materials	PC PC/ABS
Dome colour	Yellow
Housing colour	Black
Protection category	IP65
Connection	Screw terminals
cross-sectional area maximum	2,50mm ² / 14AWG
Cable entry	Through hole
Cable entry maximum	d = 11 mm
Type of fixing	Tube mounting
Working temperature minimum	-20°C
Working temperature maximum	+50°C
Weight with packaging	320 g
Product weight	251 g

ELECTRICAL DATA

Operating voltage	230V
Operating voltage type	AC
Operating voltage frequency	50Hz
Operating voltage tolerance	+/- 10%
Rated operational voltage	230 VAC
Rated operational current	30 mA
Rated inrush current	500 mA
Protection class	Protection class 2
Pollution degree	3
Overvoltage category	II
Isolation voltage	Ui = 250V; Uimp = 2.500V

OPTICAL DATA

Light source	LED
Light colour	Yellow
Optical signal image	Permanent
Service life optical	50,000 h maximum

APPROVAL DATA

Conforms with CE	Yes
WEEE	Yes



For additional installation and mounting information, refer to the appropriate user guide at www.werma.com. This printed copy is for information only and is subject to alteration.

Midi free-standing Beacons / LED Permanent-/ Blink-/ Revolving Light 829
LED Perm. Beacon RM 230VAC YE

Conforms with ATEX-directive	No
Conforms with CCC	Yes
Conforms with UL	cULus
UL Type Rating	Type 12
Conforms with FCC	No
Conforms with IC	No
EAC certificate available	Yes
Conforms with AS-I	No
ICAO Certification	No
Conforms with DNV	No
Conforms with RoHS CN	No
Conforms with VdS	No

DRAWING

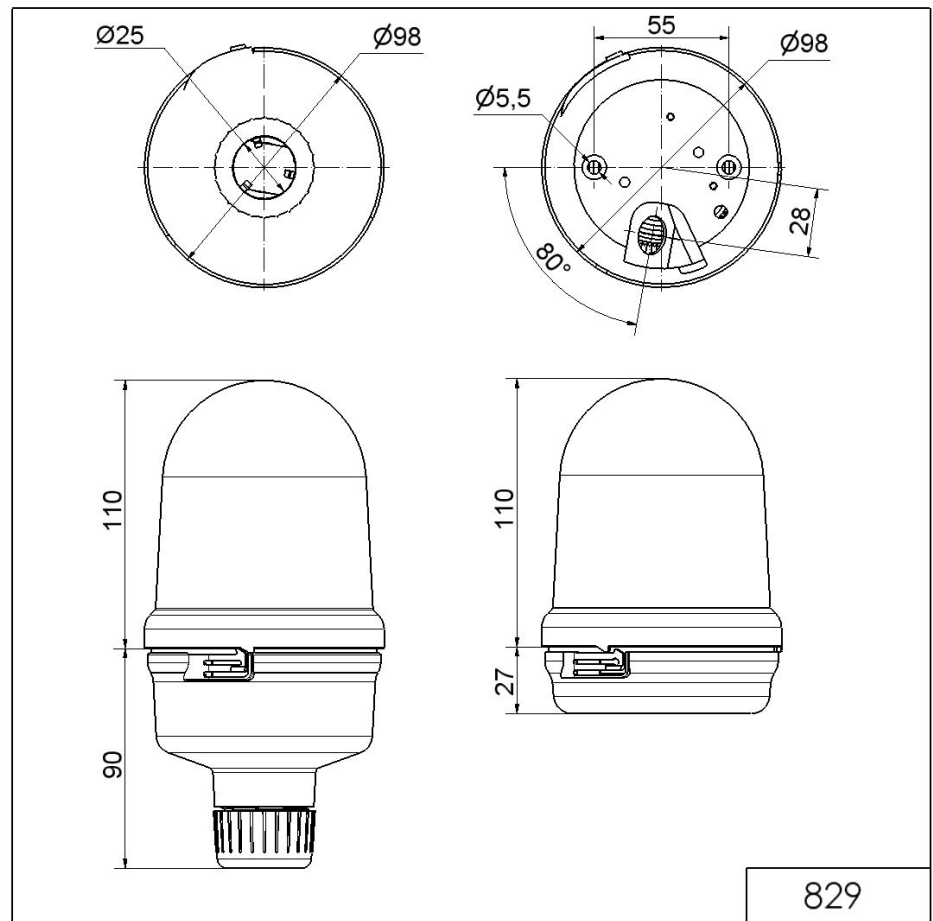

! For additional installation and mounting information, refer to the appropriate user guide at www.werma.com. This printed copy is for information only and is subject to alteration.